

### CUT

 USE A SAW TO REMOVE SUPPORTS FROM 3D PRINTED PARTS

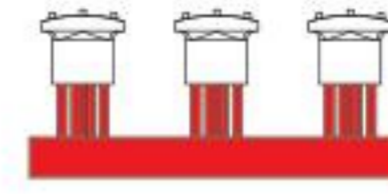

R4

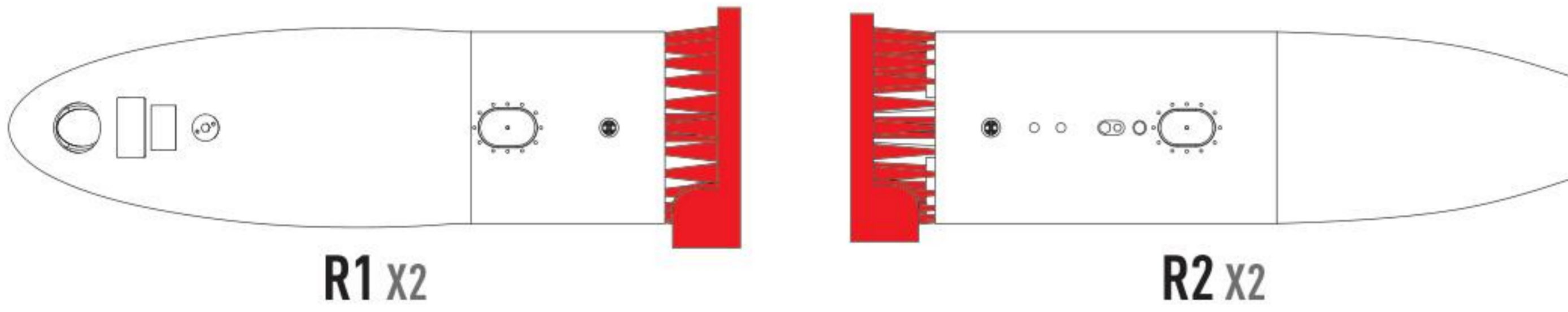

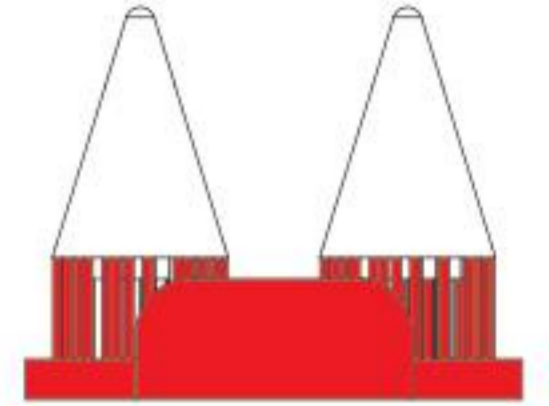

R1 X2

R2 X2

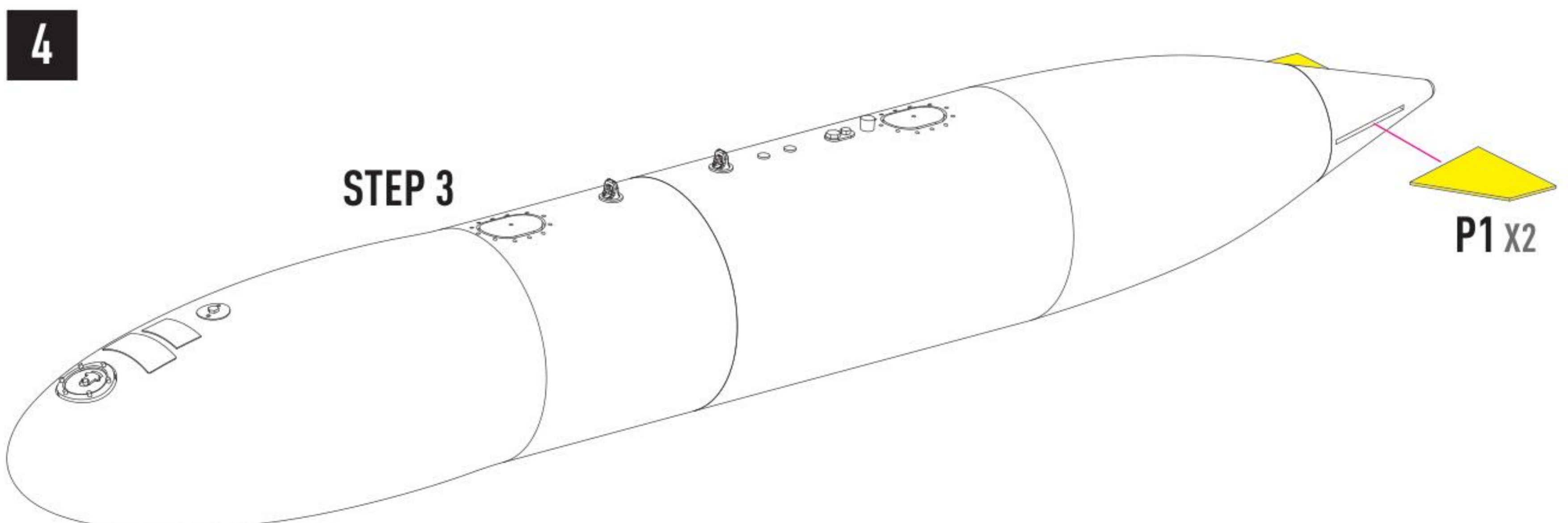
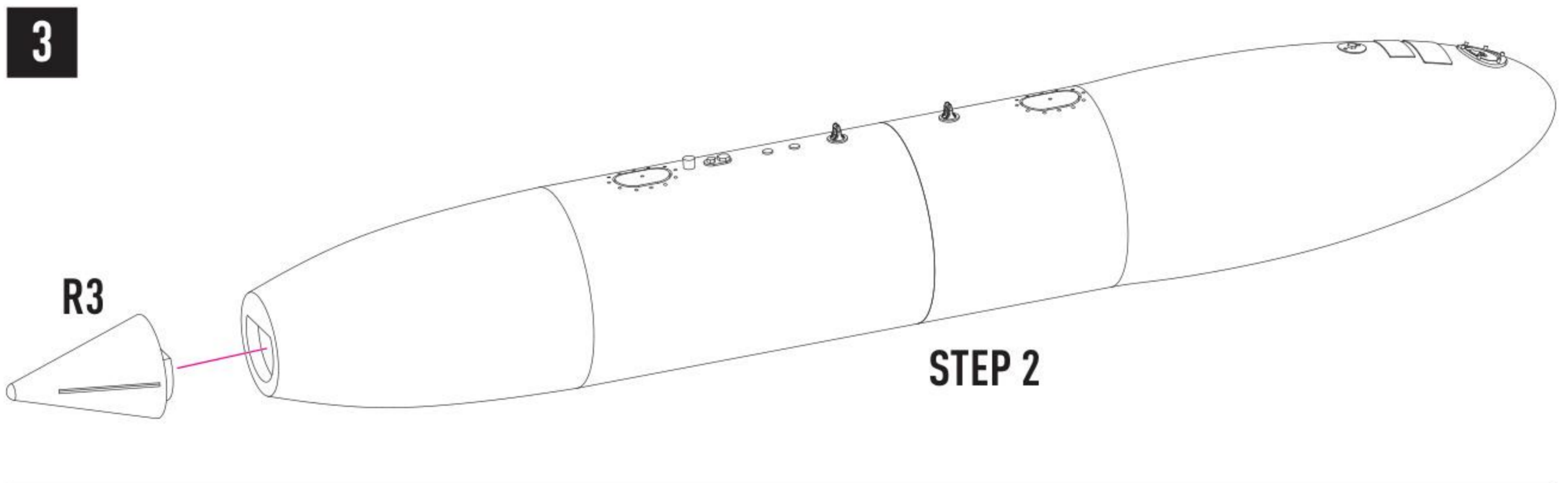
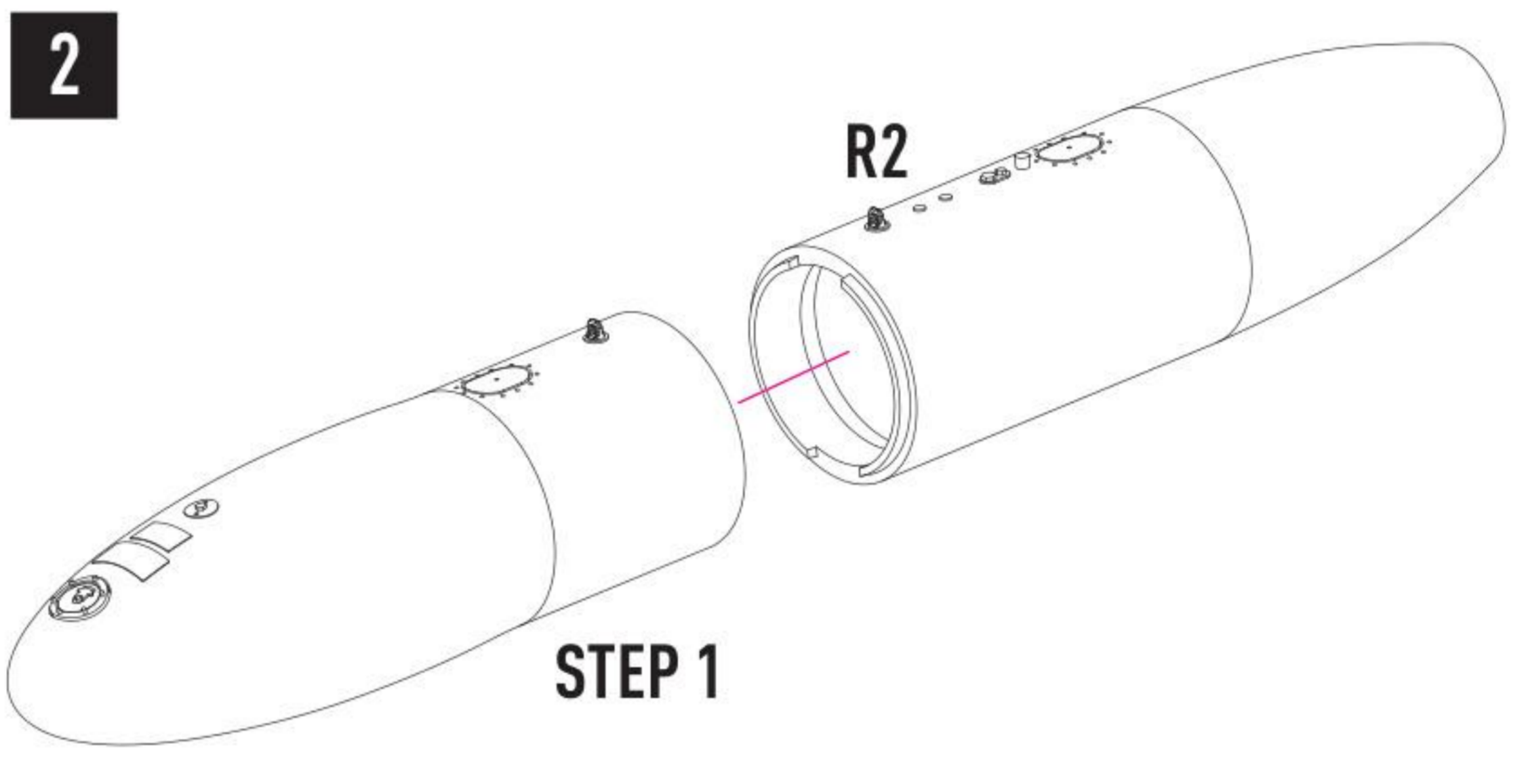
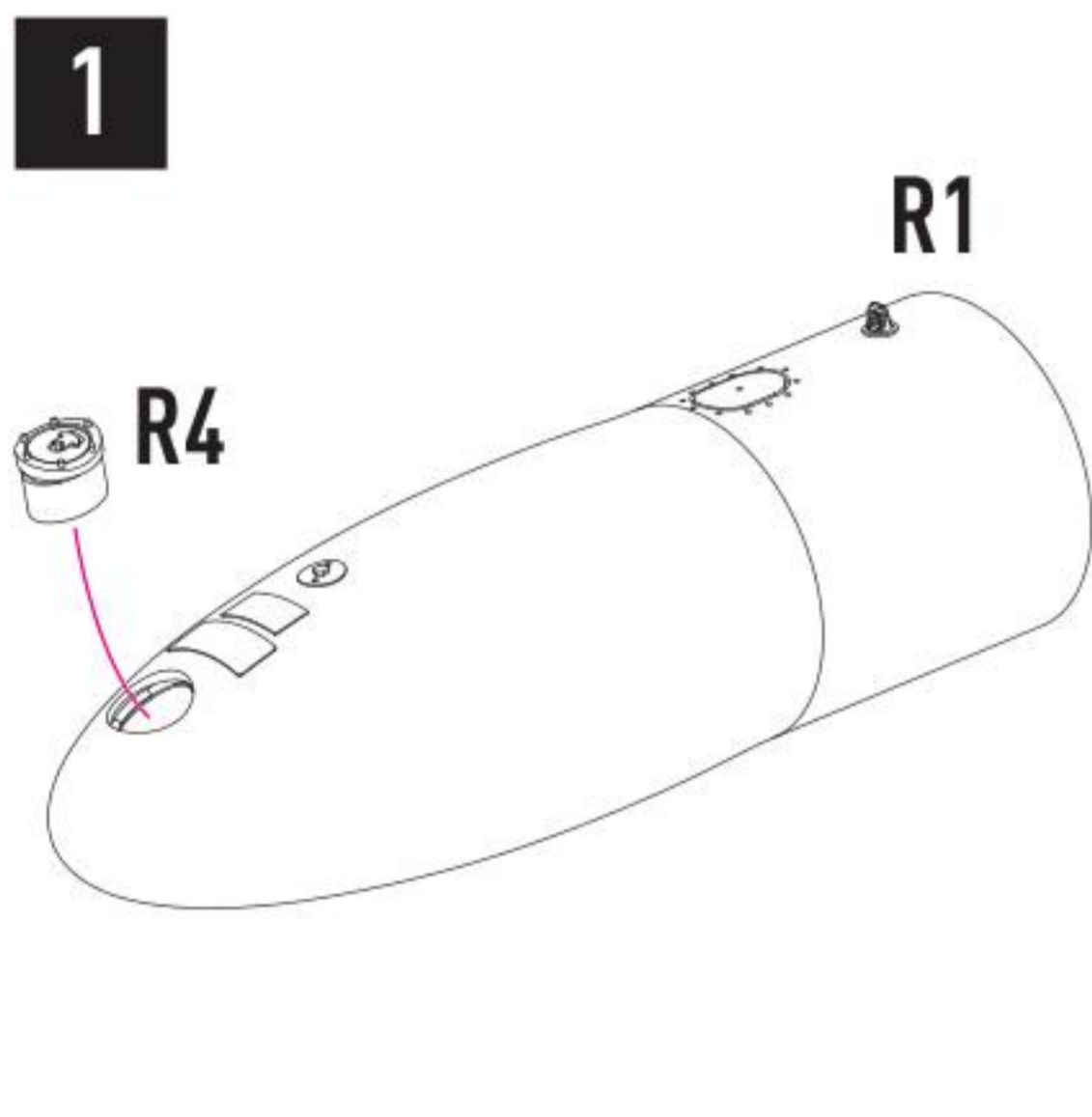

R3



COLORS	GUNZE / AQUEOUS	GUNZE / MR.COLOR	FEDERAL STANDARD
 OLIVE DRAB	H52	C12	FS 34087
 RED	H3	C3	

