

**DETAILS AFTER REMOVAL
 FROM SUPPORTS**

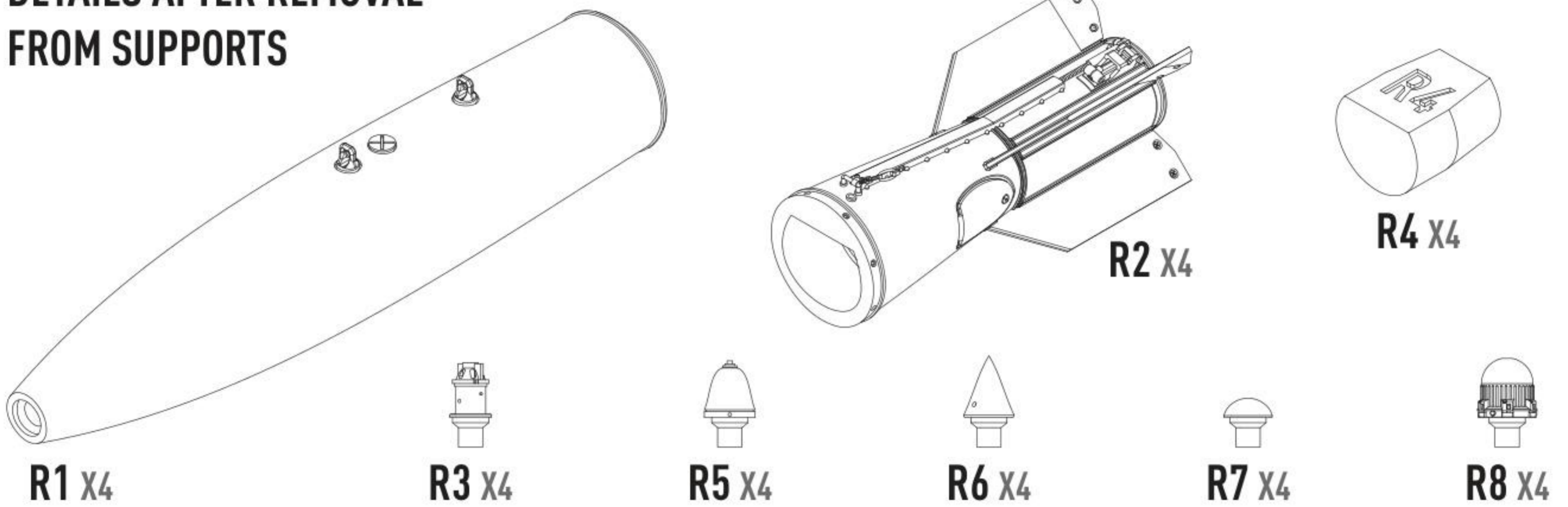

1 X4

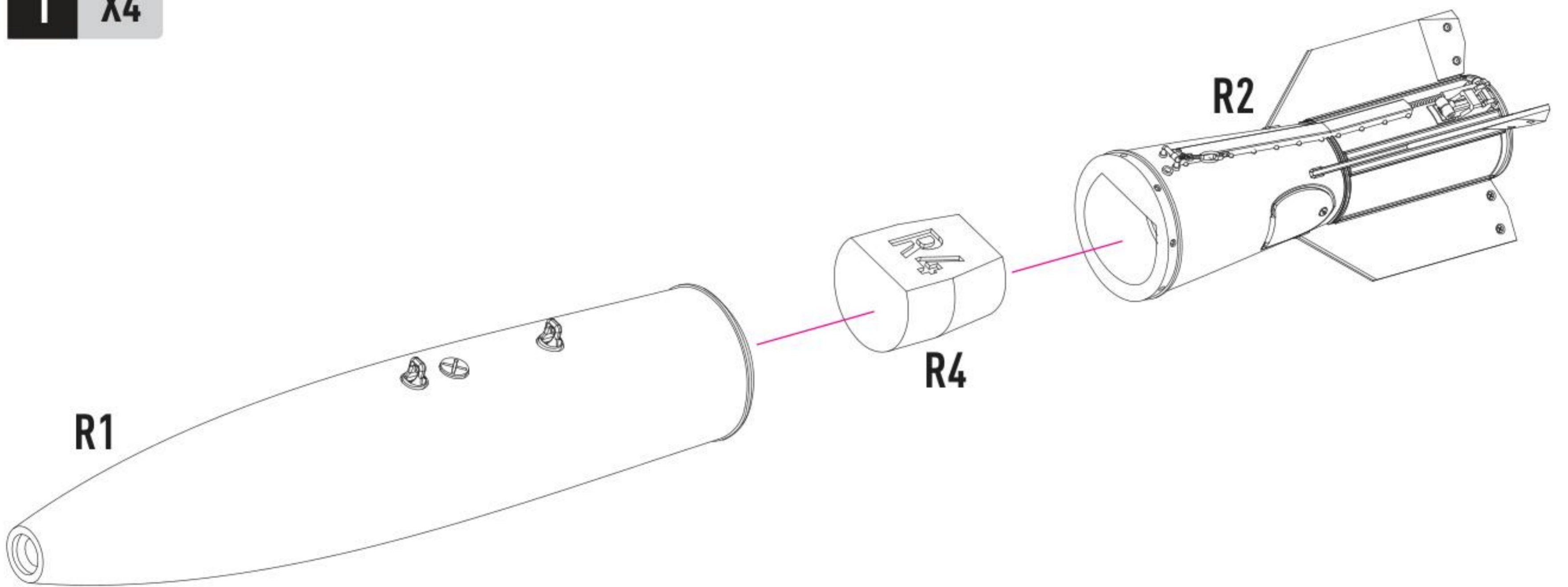



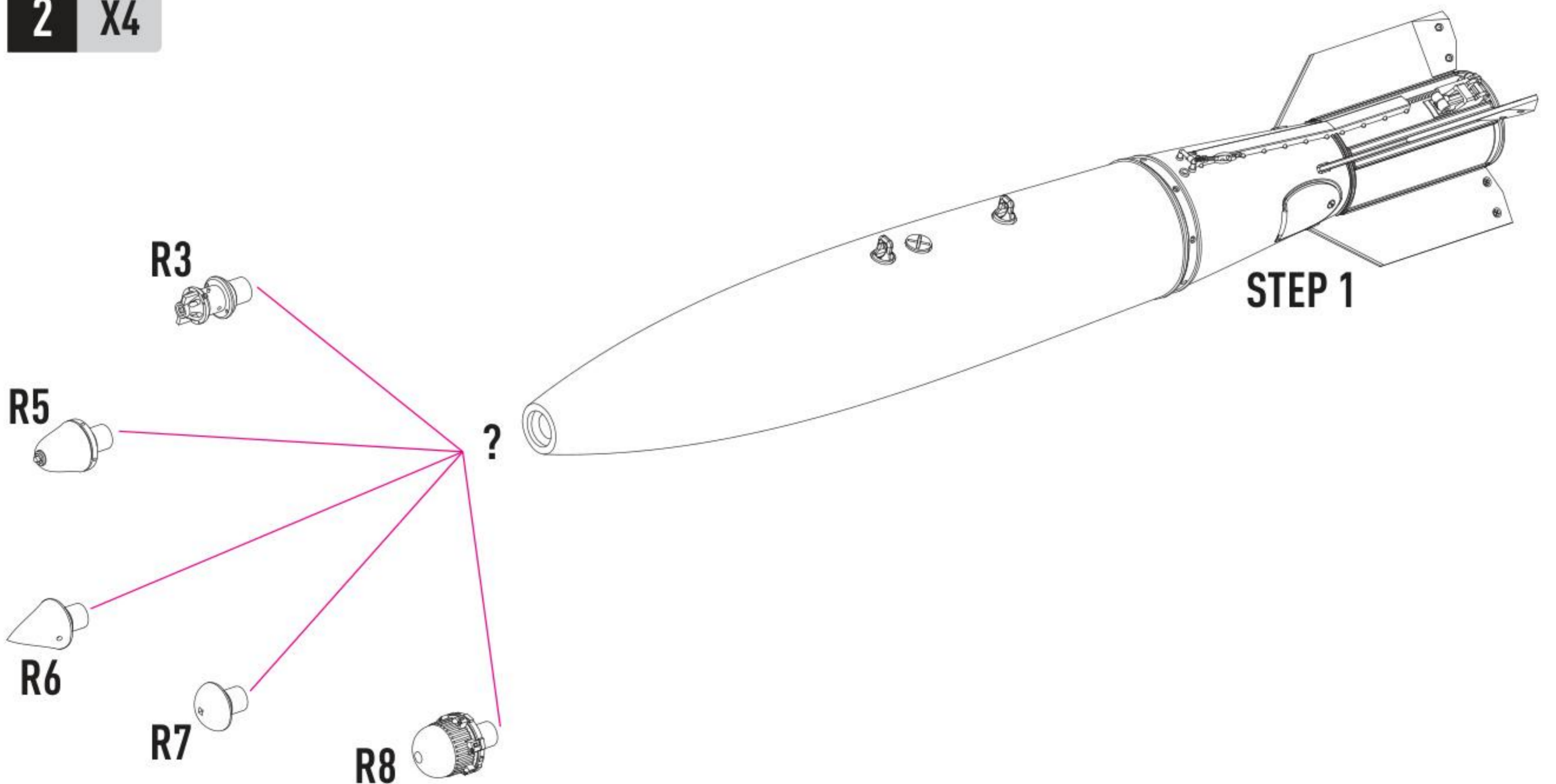

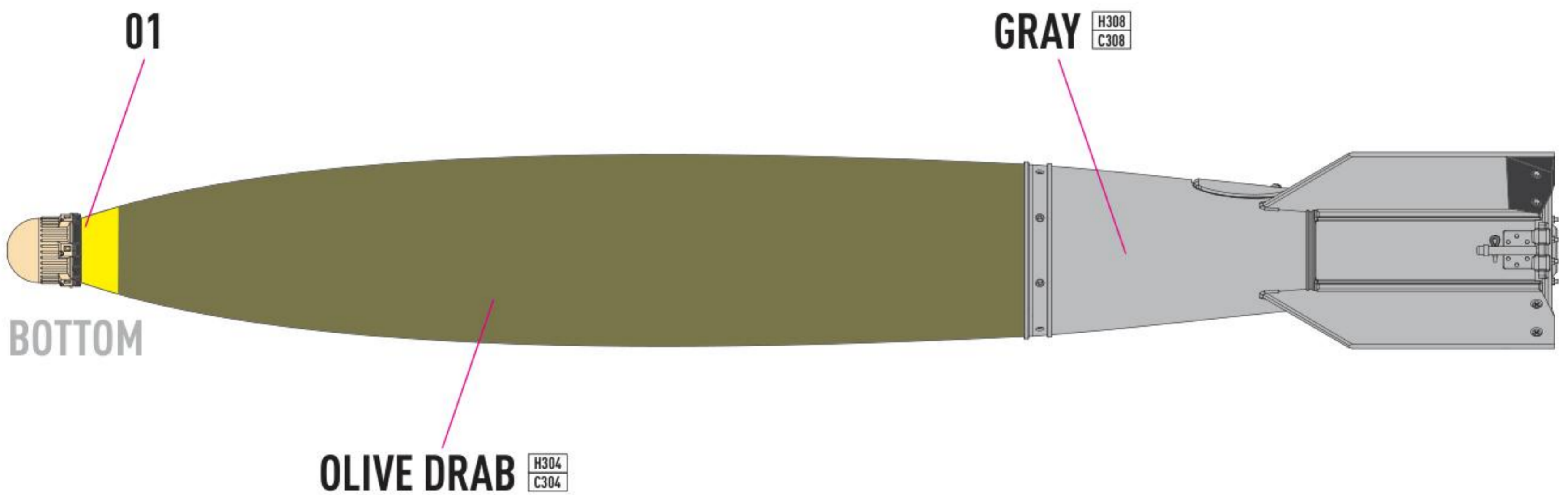
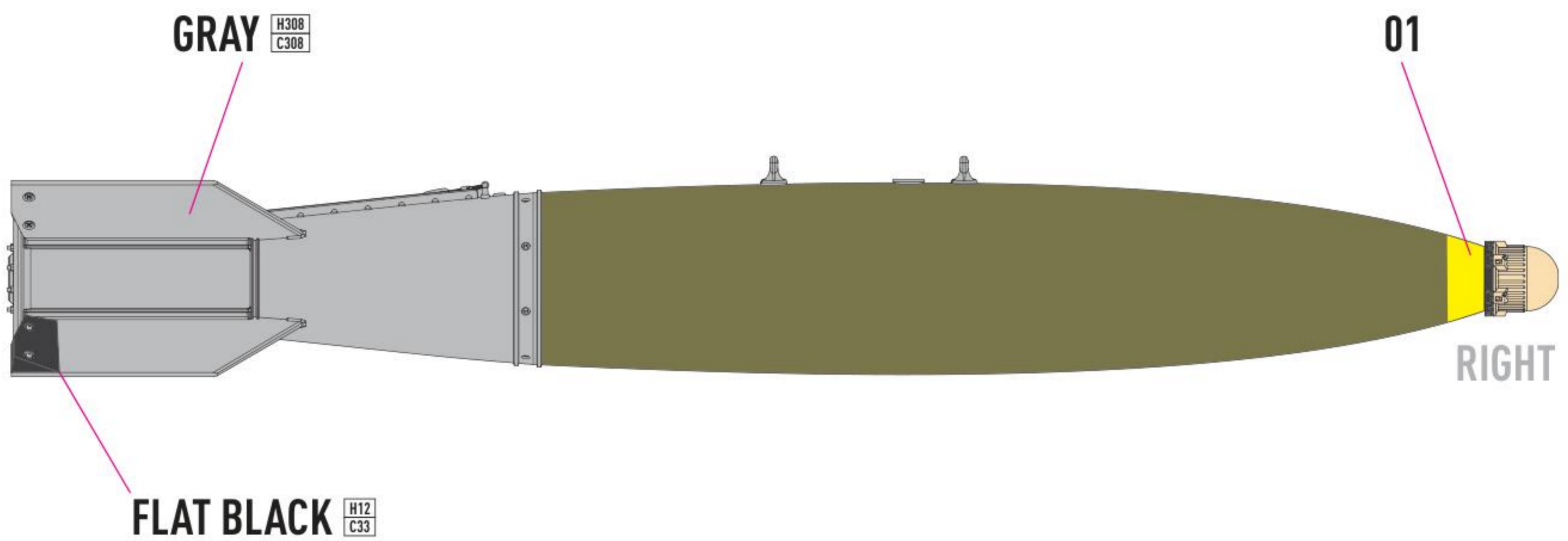
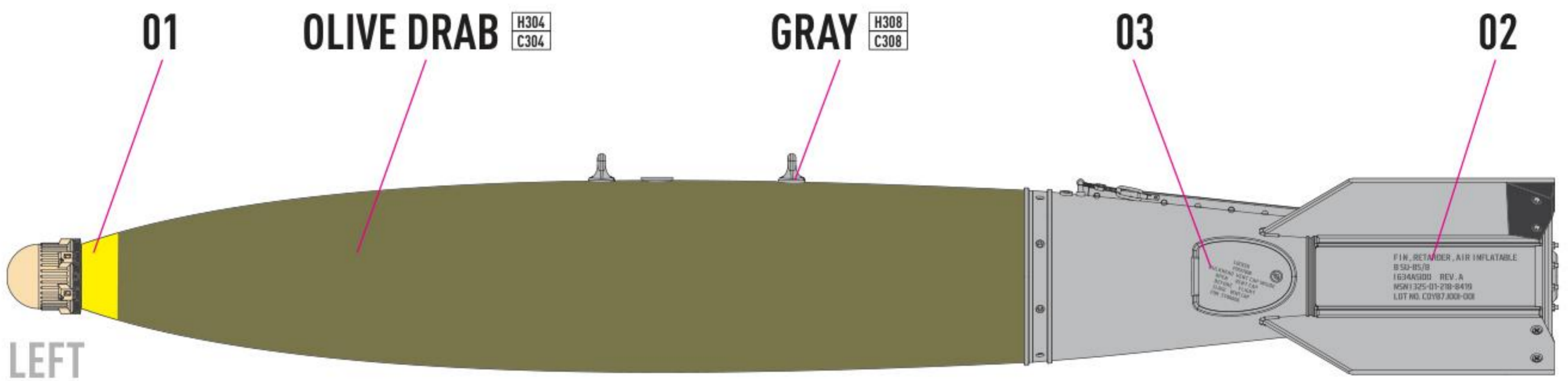
2 X4





COLORS	GUNZE / AOEIOUS	GUNZE / MR.COLOR
FLAT BLACK	H12	C33
GRAY	H308	C308
OLIVE DRAB	H304	C304

-  **R3 - M904 MECHANICAL FUSE**
-  **R5 - MK 43 TARGET DETECTING DEVICE**
-  **R6 - OGIVE NOSE PLUG**
-  **R7 - MXU-735 SOLID NOSE PLUG**
-  **R8 - DSU-33B/B RADAR PROXIMITY SENSOR**