

**DETAILS AFTER REMOVAL  
FROM SUPPORTS**

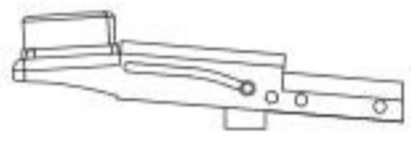

USE A SAW TO REMOVE SUPPORTS  
FROM 3D PRINTED PARTS



**R2 X4**

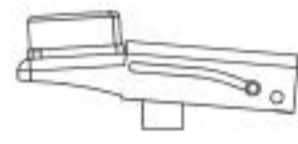

**R3 X4**



**R4 X4**

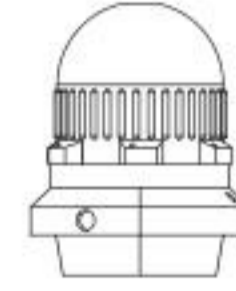

**R5 X4**

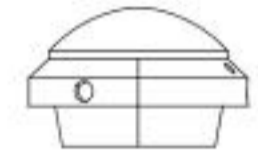

**R6 X4**

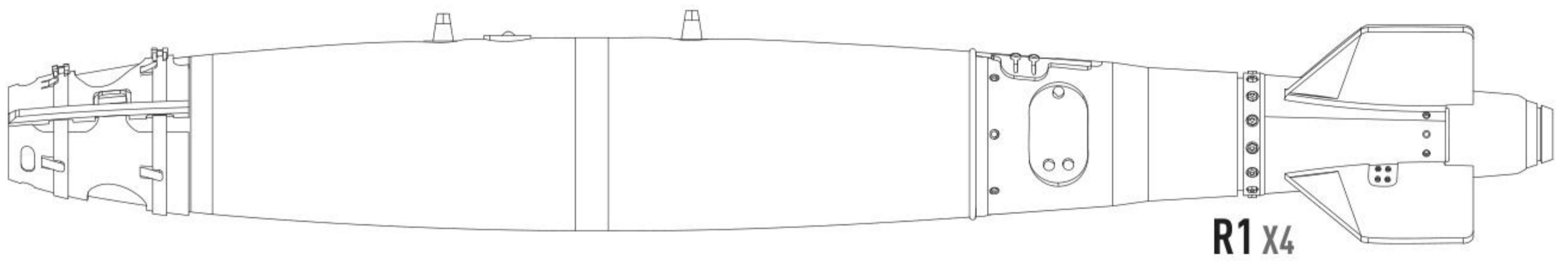

**R1 X4**

**1 X4**

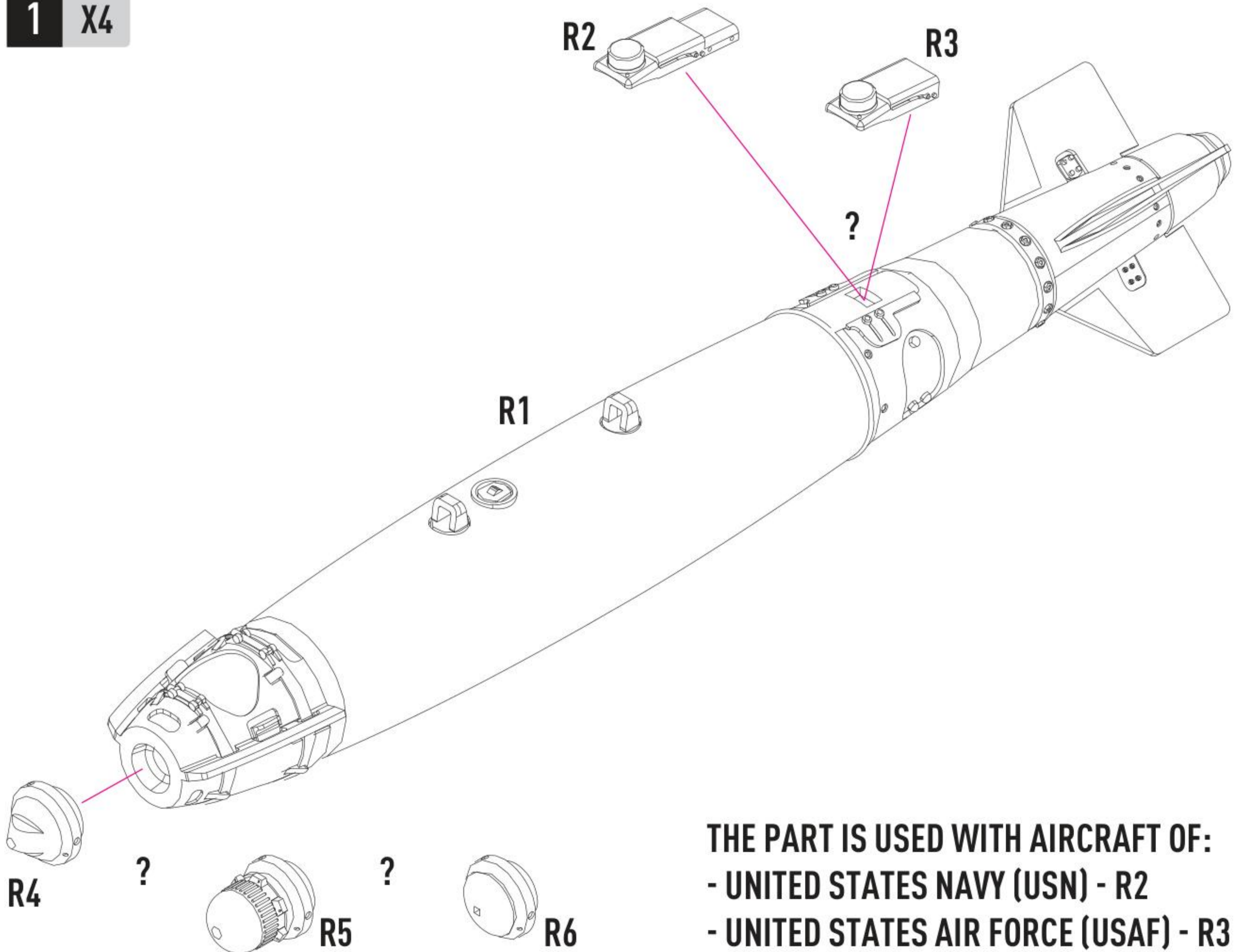



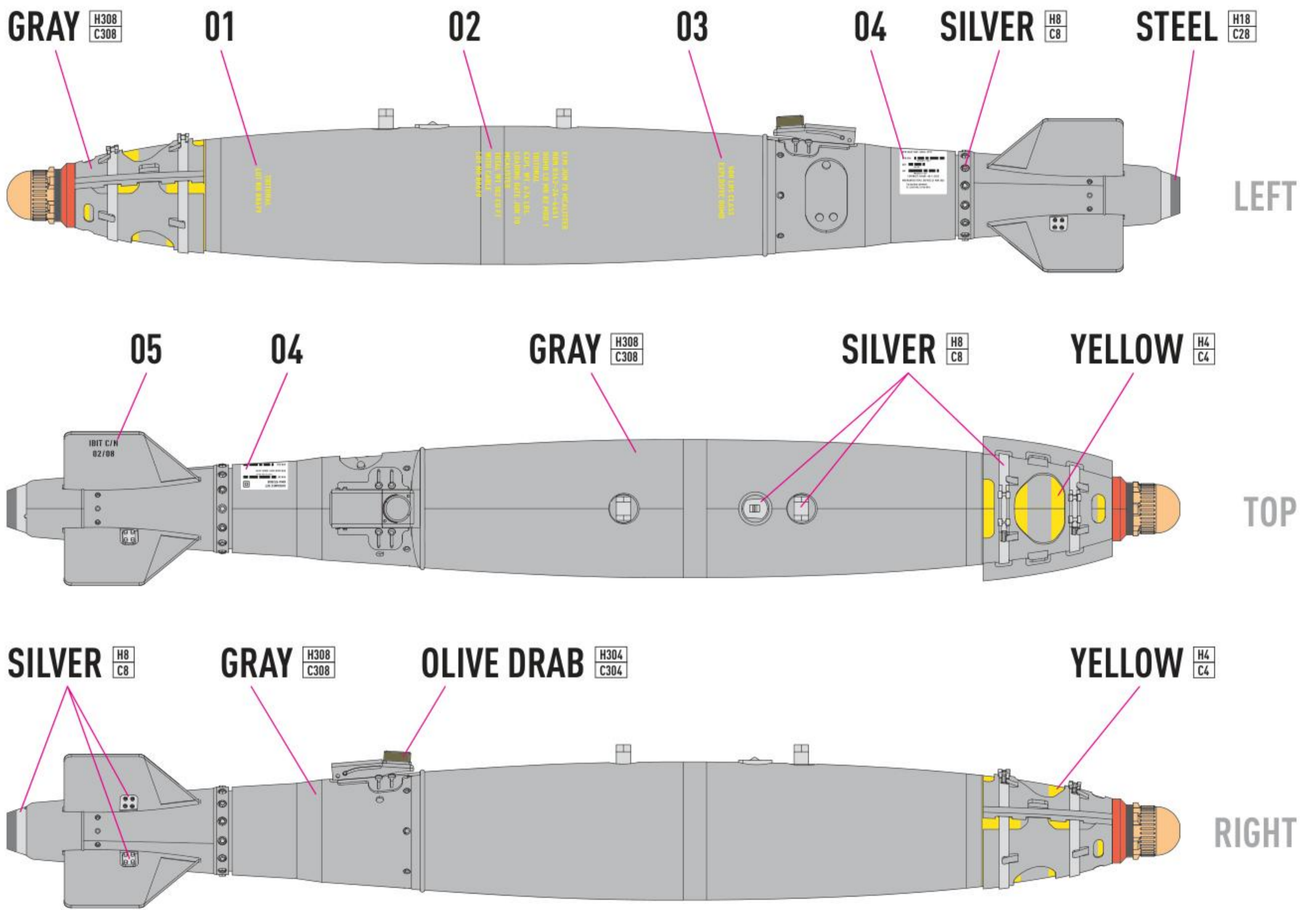

**THE PART IS USED WITH AIRCRAFT OF:**  
- UNITED STATES NAVY (USN) - R2  
- UNITED STATES AIR FORCE (USAF) - R3

COLORS	GUNZE / AQUEOUS	GUNZE / MR.COLOR	GUNZE / MR.METAL COLOR	FEDERAL STANDARD
OLIVE DRAB	H304	C304		FS 34087
YELLOW	H4	C4		FS 33538
YELLOW	H313	C313		FS 33531
GRAY	H308	C308		FS 36375
FLAT BLACK	H12	C33		
COPPER			MC215	
STEEL	H18	C28		
SILVER	H8	C8		

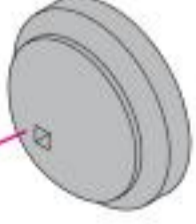

### GBU-38 FUZING OPTIONS

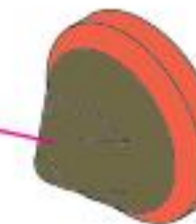
MXU-735/B BLUNT USN NOSE PLUG	 H304 / C304 OR  H308 / C308	R6
DSU-33B/B RADAR PROXIMITY SENSOR (RPS)	 H313 / C313  H12 / C33  MC215	R5
USAF NOSE PLUG	 H304 / C304  MC215	R4