

CUT

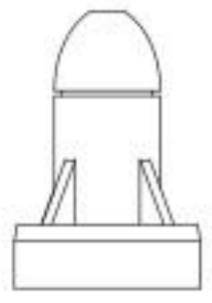

USE A SAW TO REMOVE SUPPORTS FROM 3D PRINTED PARTS



R1 X2

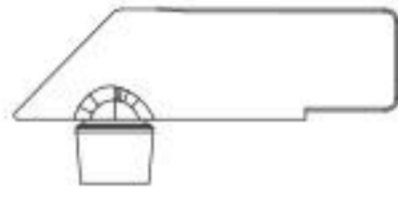

R5 X8

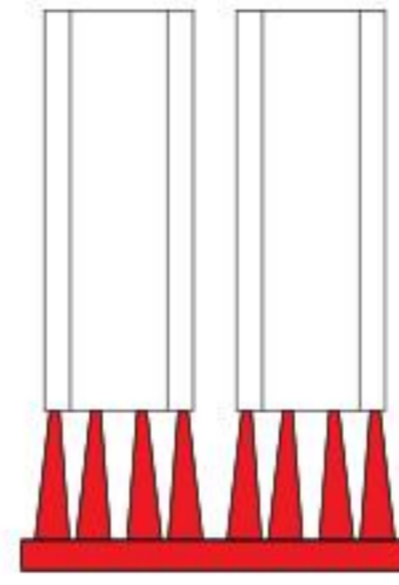

R4

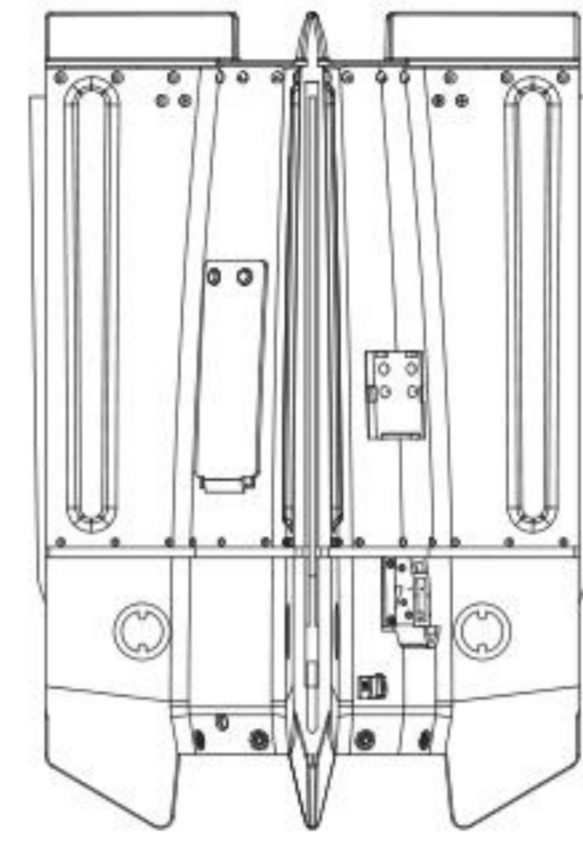

R3 X2

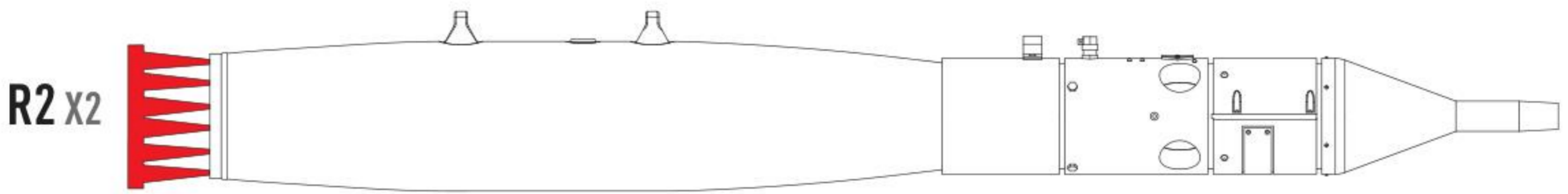

R2 X2

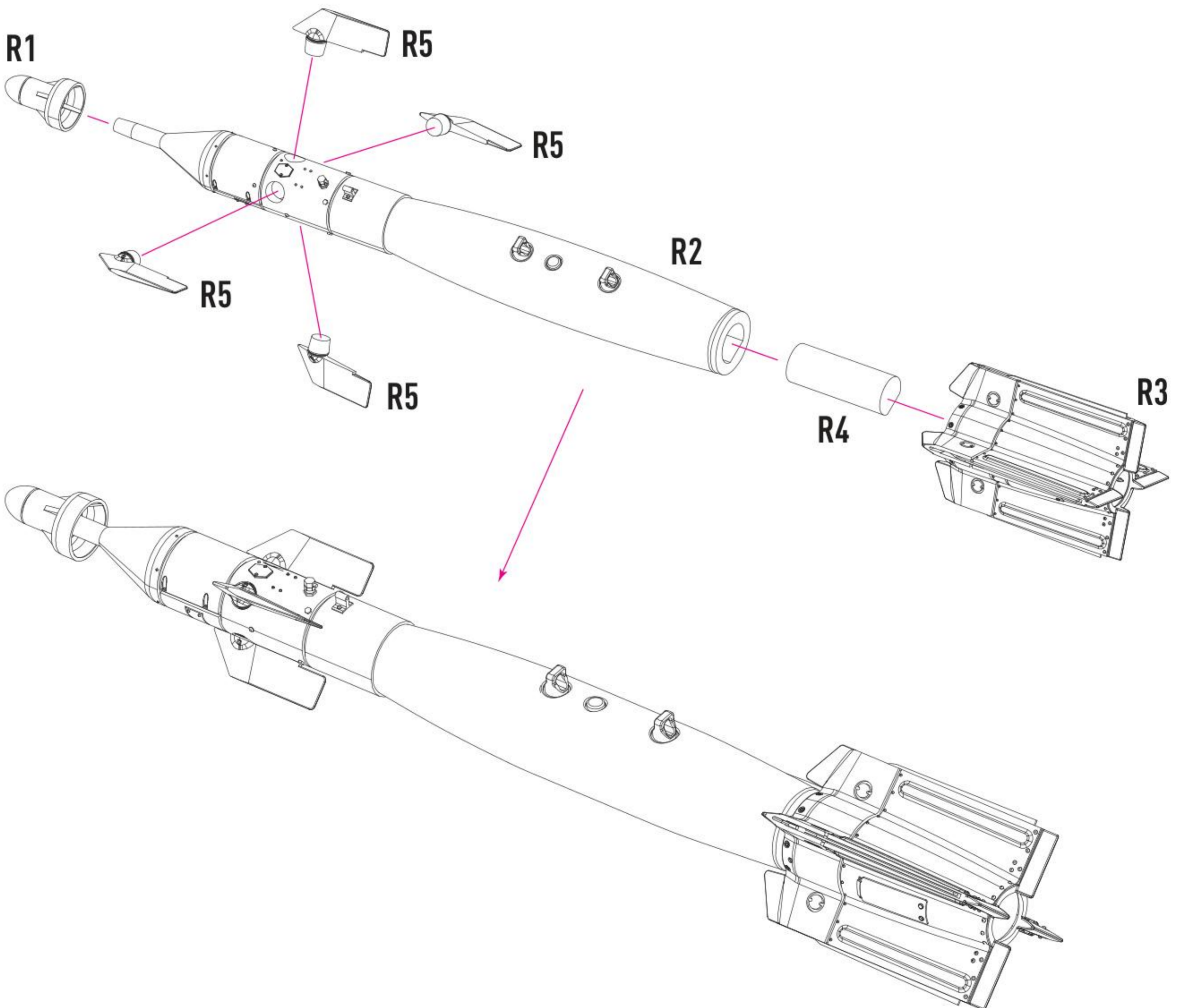

R1

R5

R5

R5

R5

R2

R4

R3

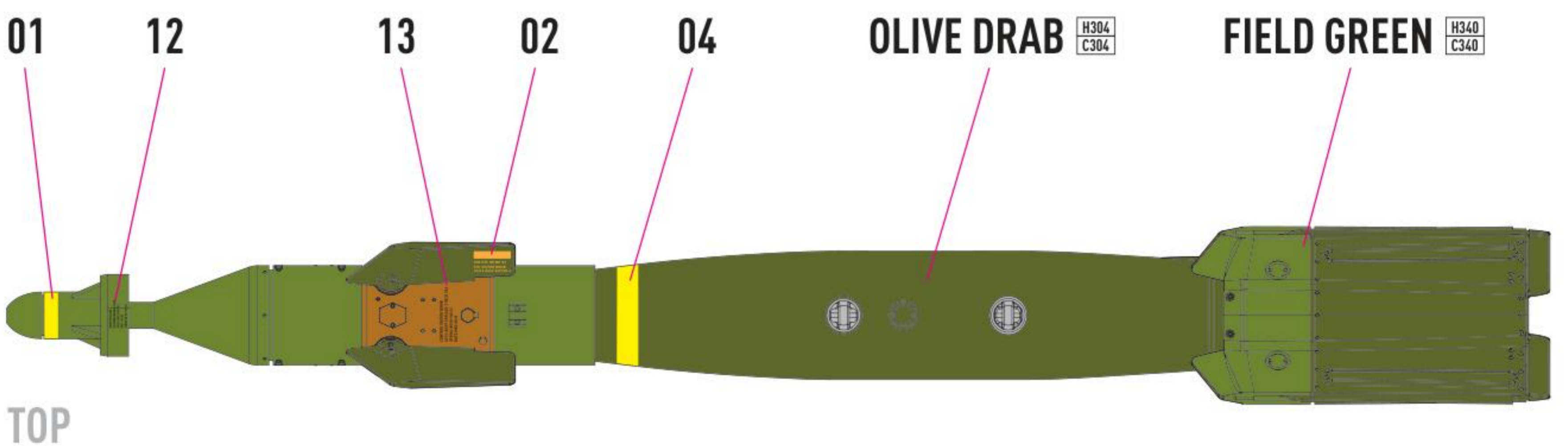
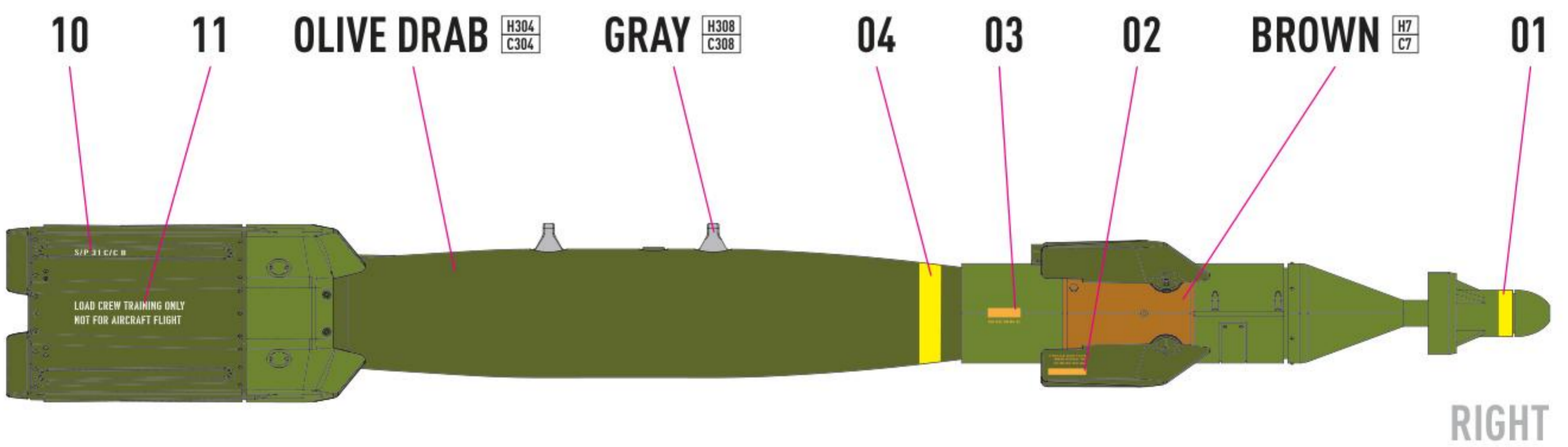
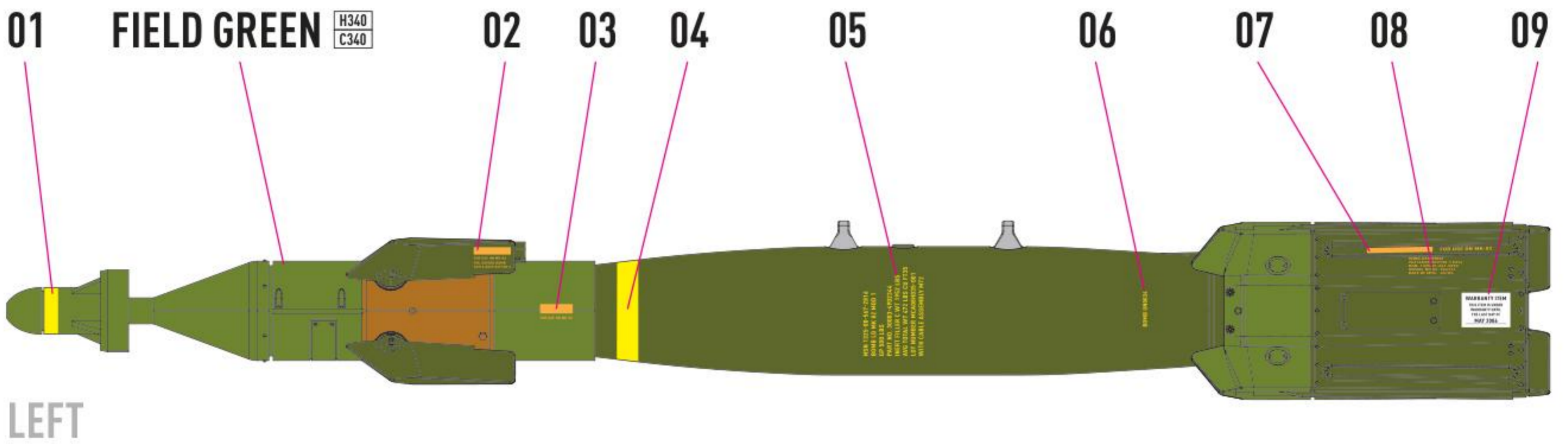

COLORS	GUNZE / AQUEOUS	GUNZE / MR.COLOR
OLIVE DRAB	H304	C304
GRAY	H308	C308

COLORS	GUNZE / AQUEOUS	GUNZE / MR.COLOR
FIELD GREEN	H340	C340
BROWN	H7	C7